

1. Features

- n $R_{DS(on)}=2.1m\Omega$ (typ.) @ $V_{GS}=10V$
- n Low On-Resistance
- n 5V Logic Level Control
- n 100% Avalanche Tested
- n Lead-Free, RoHS Compliant

2. Features

KNX2803B designed by the trench processing techniques to achieve extremely low on-resistance. Additional features of this design are a 150°C junction operating temperature, fast switching speed and improved repetitive avalanche rating. These features combine to make this design an extremely efficient and reliable device for use in Motor applications and a wide variety of other applications.

3. Pin configuration

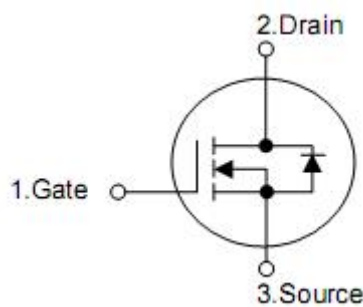
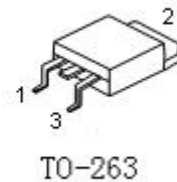
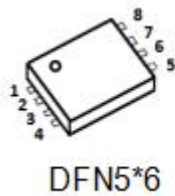

Pin DFN5*6	Pin TO-263	Function
4	1	Gate
5,6,7,8	2	Drain
1,2,3	3	Source

4. Ordering Information

Part Number	Package	Brand
KND2803B	TO-252	KIA
KNB2803B	TO-263	KIA
KNX2803B	DFN5*6	KIA

5. Absolute maximum ratings

(T_C=25 °C , unless otherwise specified)

Parameter	Symbol	Ratings		Units
		TO-252 DNF5*6	TO-263	
Drain-source voltage	V _{DSS}	30		V
Gate-source voltage	V _{GSS}	±20		V
Continuous Drain Current(VGS=4.5V) ³	I _D	T _C =25 °C	150	A
		T _C =70 °C	105	
Pulsed drain current tested T _C =25 °C ¹	I _{DM}	600		A
Avalanche energy single pulse ²	E _{AS}	625		mJ
Maximum Power dissipation T _C =25 °C	P _D	50	160	W
Maximum junction temperature	T _J	150		°C
Storage temperature range	T _{STG}	-55~+150		°C

6. Thermal characteristics

Parameter	Symbol	Rating		Unit
		TO-252 DNF5*6	TO-263	
Thermal resistance,Junction-to-case	R _{thJC}	2.5	0.79	°C/W
Thermal Resistance Junction-Ambient ²	R _{thJA}	62		°C/W

7. Electrical characteristics

(T_C=25°C, unless otherwise notes)

Parameter	Symbol	Conditions	Min	Typ	Max	Unit
Off Characteristics						
Drain-source breakdown voltage	BV _{DSS}	V _{GS} =0V, I _D =250μA	30	-	-	V
Drain-to-source leakage current	I _{DSS}	V _{DS} =24V, V _{GS} =0V	-	-	1	μA
		T _C =125 °C	-	-	100	μA
Gate-to-source leakage current	I _{GSS}	V _{GS} =20V, V _{DS} =0V	-	-	100	nA
		V _{GS} =-20V, V _{DS} =0V	-	-	-100	nA
On characteristics						
Gate threshold voltage	V _{GS(th)}	V _{DS} =V _{GS} , I _D =250μA	1.0	1.6	3.0	V
Static drain-source on-resistance ¹	R _{DS(on)}	V _{GS} =10V, I _D =40A	-	2.1	2.8	mΩ
Static drain-source on-resistance ¹	R _{DS(on)}	V _{GS} =4.5V, I _D =40A	-	2.6	3.8	mΩ
Dynamic characteristics						
Input capacitance	C _{iss}	V _{DS} =24V, V _{GS} =0V, f=1.0MHz	-	5060	-	pF
Output capacitance	C _{oss}		-	500	-	
Reverse transfer capacitance	C _{rss}		-	206	-	
Total gate charge	Q _g	V _{DS} =24V, I _D =15A, V _{GS} =10V	-	90	-	nC
Gate-source charge	Q _{gs}		-	28	-	
Gate-drain (Miller)charge	Q _{gd}		-	60	-	
Resistive switching characteristics						
Turn-on delay time	T _{d(ON)}	V _{DD} =18V, I _D =80A, V _{GS} =10V, R _G =3.3Ω	-	33	-	nS
Rise time	t _{rise}		-	60	-	
Turn-off delay time	T _{d(OFF)}		-	36	-	
Fall time	t _{fall}		-	42	-	
Source-drain body diode characteristics T_J=25°C, unless otherwise notes						
Diode continuous forward current ¹	I _S	T _J =25°C	-	-	150	A
Diode forward voltage ¹	V _{SD}	V _{GS} =0V, I _{SD} =20A	-	0.82	1.3	V

Note: 1. Pulse width ≤300μs; duty cycle ≤2%.

2. Limited by T_{Jmax}, Starting T_J=25°C. L=1mH R_G=25Ω, I_{AS}=36A, V_{GS}=10V,

Part not recommended for use above this value.

3. Repetitive rating; pulse width limited by max, junction temperature.

8. Typical characteristics

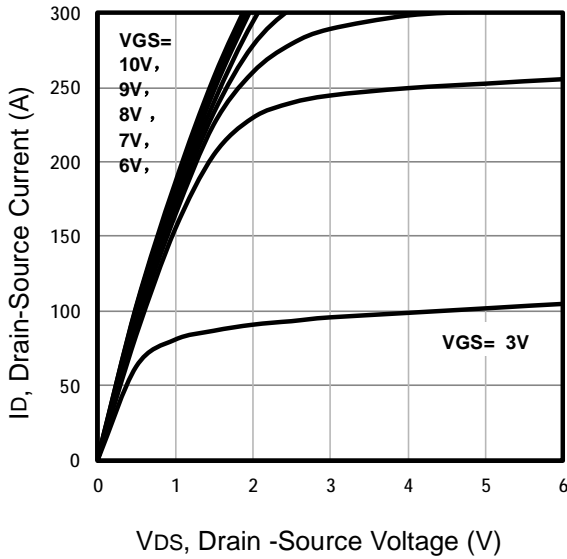

Fig1. Typical Output Characteristics

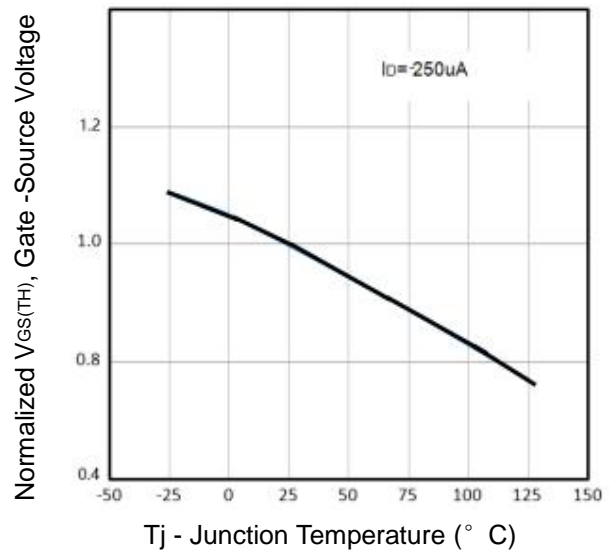

Fig2. Normalized Threshold Voltage Vs. Temperature

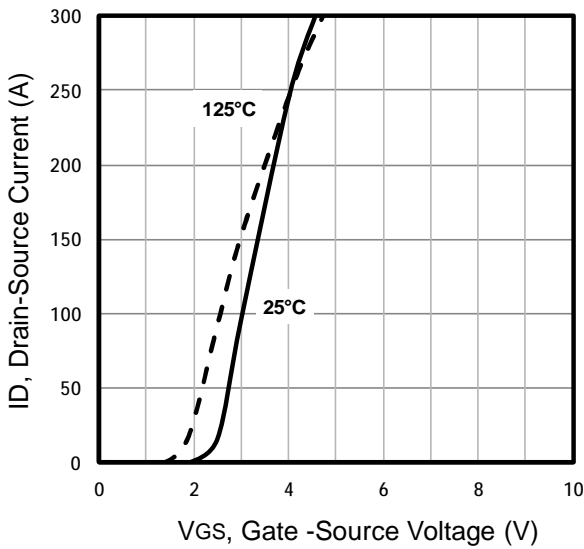

Fig3. Typical Transfer Characteristics

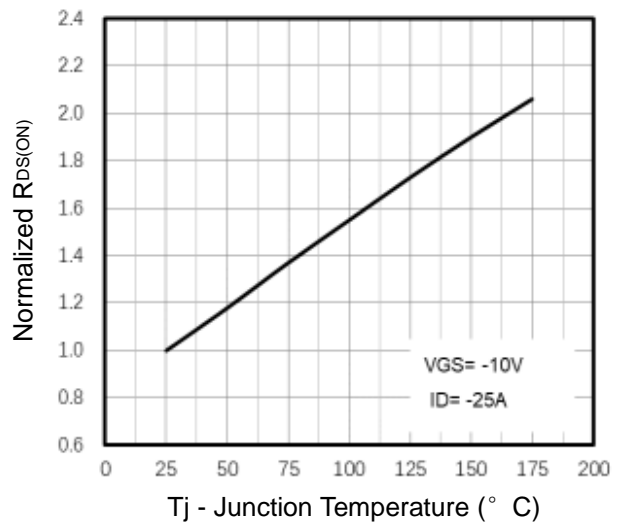

Fig4. Normalized Threshold Voltage Vs. Temperature

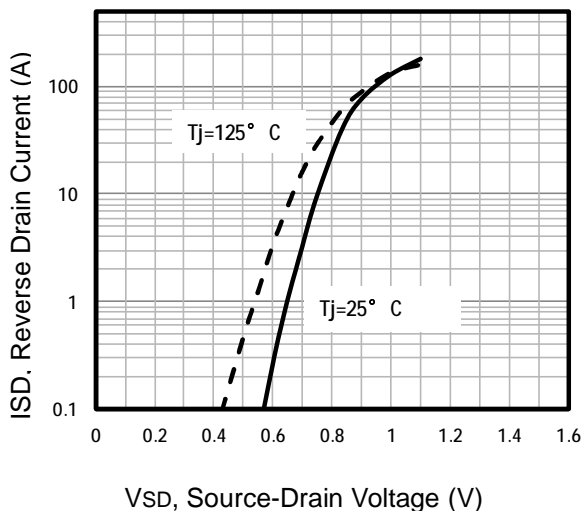

Fig5. Typical Source-Drain Diode Forward

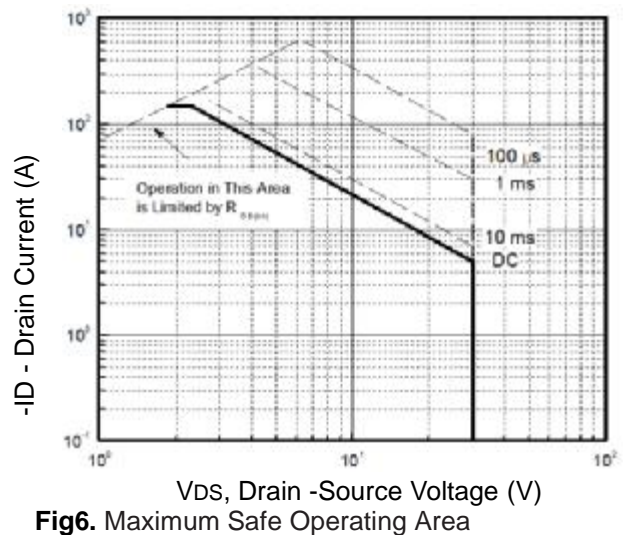

Fig6. Maximum Safe Operating Area

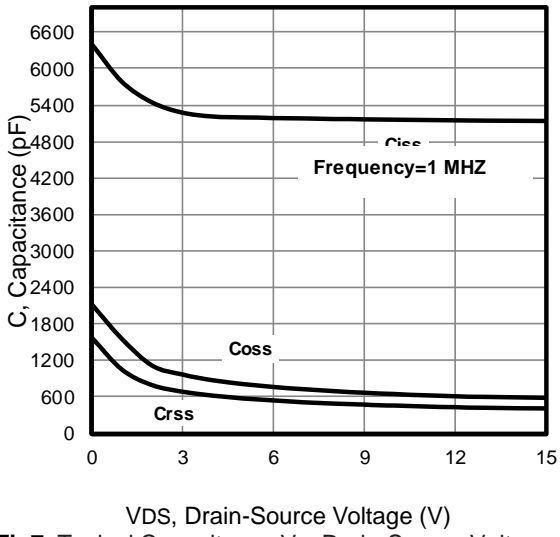

Fig7. Typical Capacitance Vs. Drain-Source Voltage

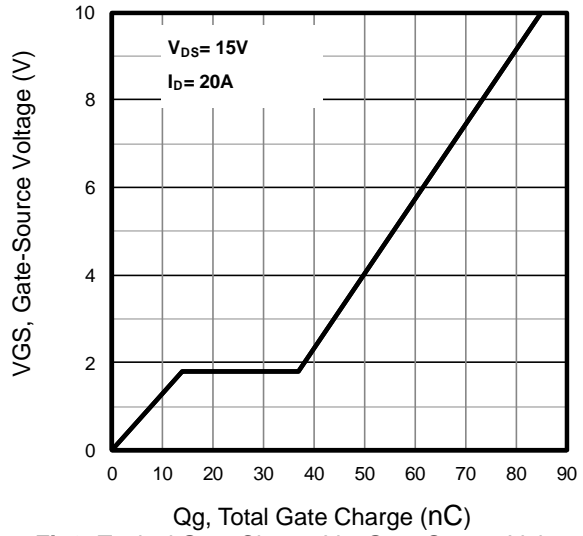

Fig8. Typical Gate Charge Vs. Gate-Source Voltage

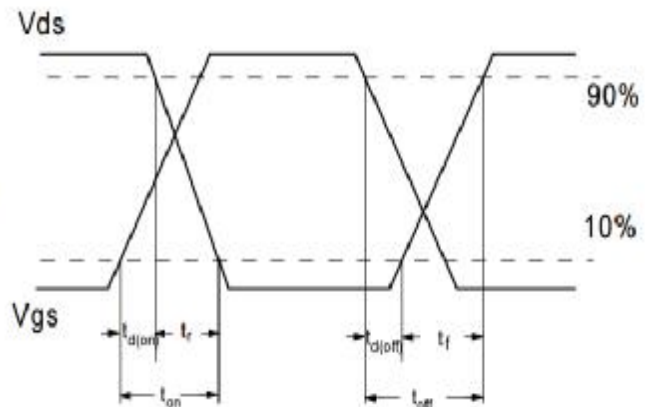
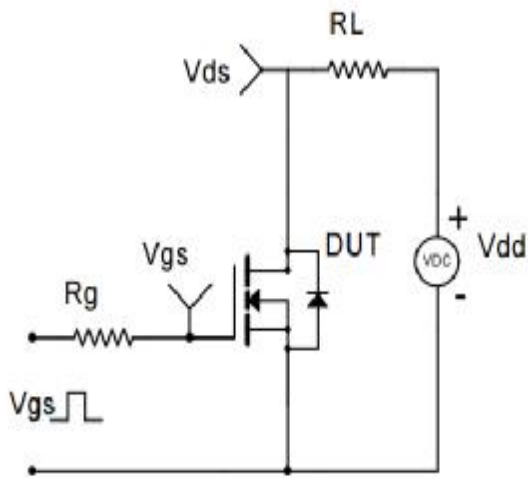

Fig9. Switching Time Test Circuit and waveforms